

eve aqua 

Como começar

Como começar

①

Coloque as pilhas AA incluídas antes de iniciar a instalação.

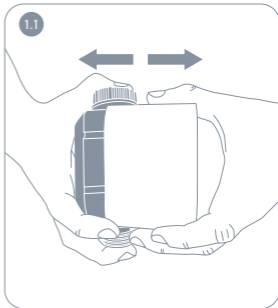

Como começar

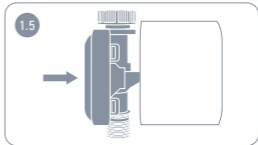
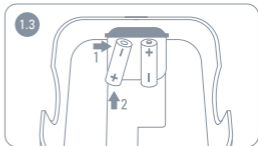
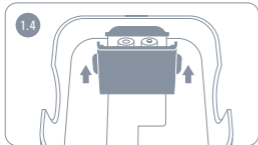
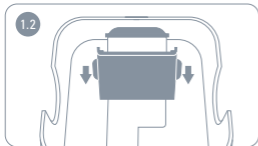

Como começar

②

Ligue o Eve Aqua à torneira e coloque uma mangueira na outra extremidade.

i

Atenção: garanta que o Eve Aqua não fica exposto ao gelo.

Como começar

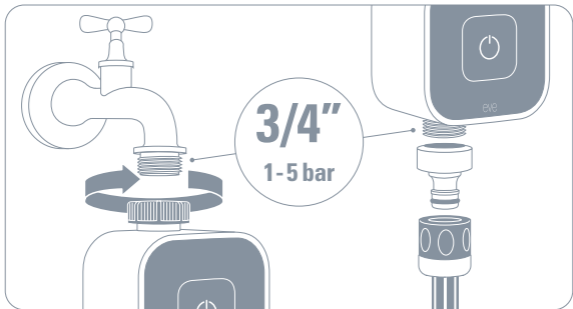

Como começar

3

Faça download da app Eve na App Store.

 Eve



Download on the
App Store

Como começar



Como começar

④

Abra a aplicação Eve e adicione o acessório.
A aplicação dará indicações de como o configurar.

Add Accessory

Como começar

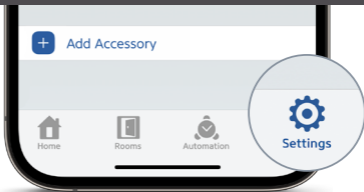

Se já tem mais acessórios configurados na aplicação, vá a Settings e adicione o Eve Aqua.

Aproveite

5 Controle o Eve Aqua com a aplicação Eve, Home app e Siri.



Controlar



Activar bloqueio infantil



Instalar atualizações de firmware



Configure horários



Monitorar consumo de água



Controlar



Configurar acesso a convidados



Controlar

Aproveite

⑥

Também poderá carregar no botão para começar ou parar a rega.

ⓘ

Eve Aqua irá desligar-se automaticamente quando a duração por defeito, configurada na App Eve, terminar.

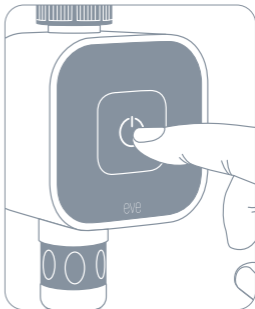

Aproveite

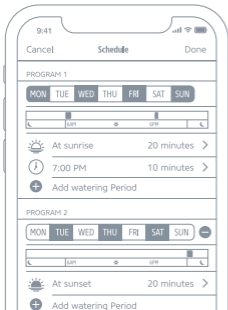

Os horários controlam a Eve Aqua automaticamente, independentemente do iPhone ou home hub. Configure horários para regar automaticamente a horários específicos através da App Eve.

Aproveite



**100 %
Privacy**



No Eve Cloud



No Registration



No Tracking

Eve é concebida para proteger os seus dados pessoais. Todos os dados são completamente encriptados e transferidos directamente apenas entre o seu Eve Aqua e iPhone, iPad ou home hub. Saiba mais em evehome.com/privacy.

Reinicializar

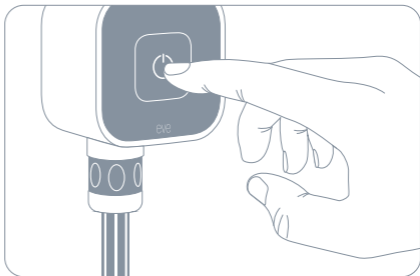
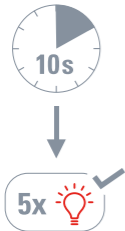



Mantenha o seu código de Setup HomeKit num lugar seguro.
Precisará dele para adicionar Eve à sua casa e e mais ninguém
além de si o conhece ou tem uma cópia.

Product: 10ECC8101 • Model: 20ECC8101 • Part: 51ECC9901

Powered by



eve aqua 



Sala:.....

Notas:.....