

eve aqua 

Primeros pasos

Primeros pasos

①

Inserte las pilas AA incluidas antes de continuar con la instalación.

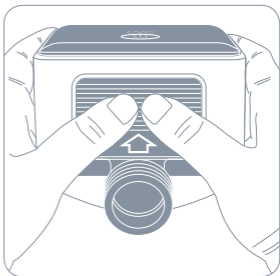

Primeros pasos

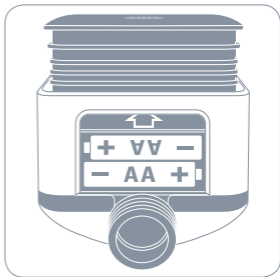
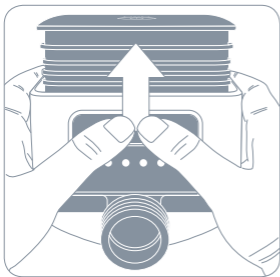

Primeros pasos

②

Monte Eve Aqua en el grifo y conecte una manguera.

i

Atención: Asegúrese de que Eve Aqua nunca llegue a congelarse.

Primeros pasos

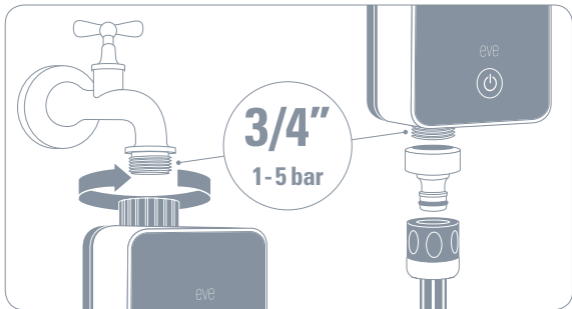

3

Descargue la app Eve desde el App Store.

 Eve



Consíguelo en el
App Store

Primeros pasos

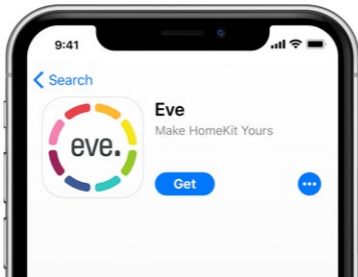

Primeros pasos

4

Abra la app Eve y toque Añadir accesorio. Eve le guiará por el proceso de configuración.



Add Accessory

Primeros pasos

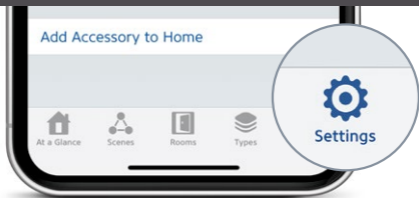

Si ya ha configurado otro accesorio, vaya a los Ajustes de Eve para añadir Eve a su casa.

5

Controle Eve Aqua desde la app o con Siri. También puede pulsar el botón para empezar e interrumpir el riego.

i

Eve Aqua se apagará automáticamente cuando se haya agotado el tiempo predefinido configurado en la app Eve.

Disfrute

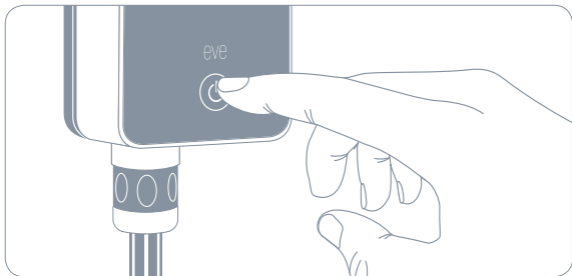

Información legal

This device complies with part 15 of the FCC Rules and Industry Canada licence-exempt RSS standard(s). Operation is subject to the following two conditions: (1) This device may not cause interference, and (2) this device must accept any interference received, including interference that may cause undesired operation.

This equipment has been tested and found to comply with the limits for a Class B digital device, pursuant to part 15 of the FCC Rules. These limits are designed to provide reasonable protection against harmful interference in a residential installation. This equipment generates, uses and can radiate radio frequency energy and, if not installed and used in accordance with the instructions, may cause harmful interference to radio communications. However, there is no guarantee that interference will not occur in a particular installation. If this equipment does cause harmful interference to radio or television reception, which can be determined by turning the equipment off and on, you are encouraged to try to correct the interference by one or more of the following measures: reorient or relocate the receiving antenna; increase the separation between the equipment and receiver; consult the dealer or an experienced radio/TV technician for help.

This Class B digital apparatus complies with Canadian ICES-003.

This equipment complies with FCC RF and IC RSS-102 radiation exposure limits set forth for an uncontrolled environment. This equipment should be installed and operated with a minimum distance of 0.5 centimeters between the radiator and your body. This transmitter must not be co-located or operating in conjunction with any other antenna or transmitter. The antennas used for this transmitter must be installed to provide a separation distance of at least 0.5 cm from all persons and must not be co-located or operating in conjunction with any other antenna or transmitter.

Changes or modifications not expressly approved by Eve Systems could void your authority to operate this

Información legal

device. Purpose of control: operating control; construction of control: plug-in operating control; type 1 action, operating time: continuous.

For questions about Eve product compliance with FCC regulations, please contact: Compliance Officer, Eve Systems, 900 Kearny St. #750, San Francisco, CA 94133.

Por la presente, Eve Systems declara que este dispositivo cumple los requisitos básicos y otras estipulaciones de la Directiva 2014/53/EC. Para obtener una copia de la declaración de conformidad, visite www.evehome.com/doc

Intervalo de frecuencias: 2402 - 2480 MHz, potencia radiada aparente máxima de 3 dBm

Intervalo de temperaturas: 4 °C - 50 °C

Producto: 10EAI8101, 10EAI4101 • Modelo: 20EAI8101, 20EAI4101 • Pieza: 51EAI9902

FCC ID: SNE-WHV-001 • IC: 11192A-WHV001

Restablecer

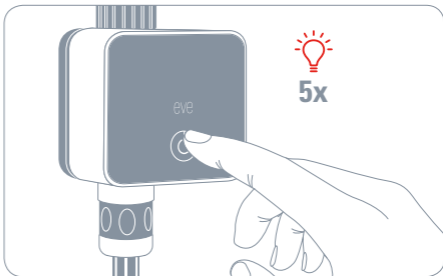



Guarde el código de configuración de HomeKit a buen recaudo.
Lo necesitará para añadir de forma segura Eve a su casa. Solo
usted tiene una copia.

Powered by



eve aqua 



Habitación:.....

Notas:.....